



## DP2100LA&amp;DP2100SA&amp;DP2100TA

半导体放电管

版本号  
201603-A

## 产品概述

半导体放电管是一种过压保护器件，是利用晶闸管原理制成的，依靠PN结的击穿电流触发器件导通放电，可以流过很大的浪涌电流或脉冲电流。

## 产品特点

- 双向过电压电路保护
- 抗浪涌能力强
- 快速反应，可恢复
- 漏电小，可靠性高
- 低电容

## 特征参数

符号	额定值	单位
$V_{DRM}$	180	V
$V_S$	240	V
$I_H$	150	mA

## 应用领域

DP2100半导体放电管主要应用于通讯设备的过电压防护；家用电器，工控仪器的过电压防护。

封装：SMB (DO-214AA)，DO-15，SMA (DO-214AC)

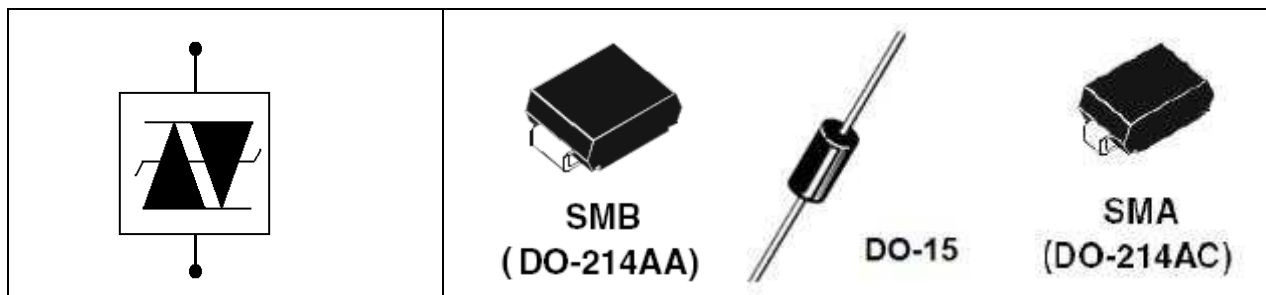

## 电参数

参数名称	符号	测试条件	规范值			单位
			最小	典型	最大	
不动作电压	$V_{DRM}$	$I=5\mu A$	180			V
不动作电流	$I_{DRM}$	$V=V_{DRM}$ 额定值			5	$\mu A$
跃变电压	$V_S$	100KV/s			240	V
跃变电流	$I_S$	100KV/s			800	mA
维持电流	$I_H$	10A, 10/1000 $\mu s$	150			mA
通态电压	$V_T$	$I_T=2.2A$			4	V
通态电流	$I_T$	额定值		2.2		A
极间电容	$C_o$	1MHz, 2V偏置			35	pF
峰值浪涌电流	$I_{PP}$	10/1000 $\mu s$			50	A

■ 热特性

符号	参数	数值	单位
$T_J$	工作结温范围	-40~+150	°C
$T_S$	贮存温度范围	-65~+150	°C

■ 典型特性曲线

浪涌电流波形

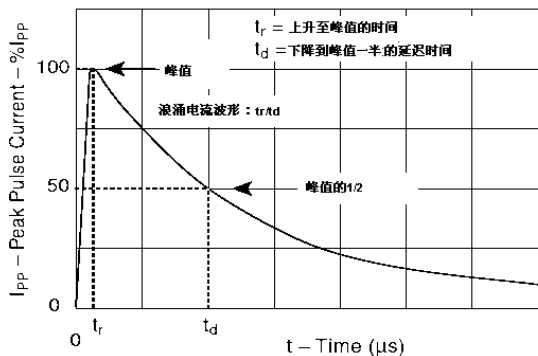

$I_H$  随温度变化率

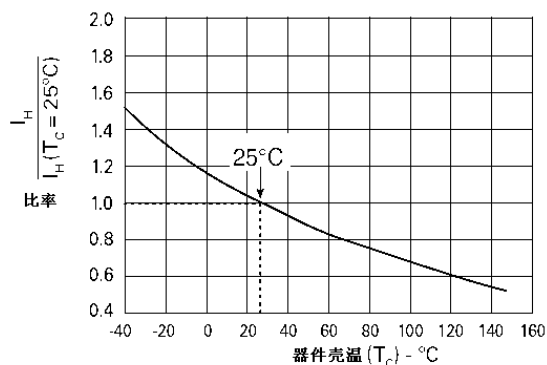

$V_S$  随结温变化率

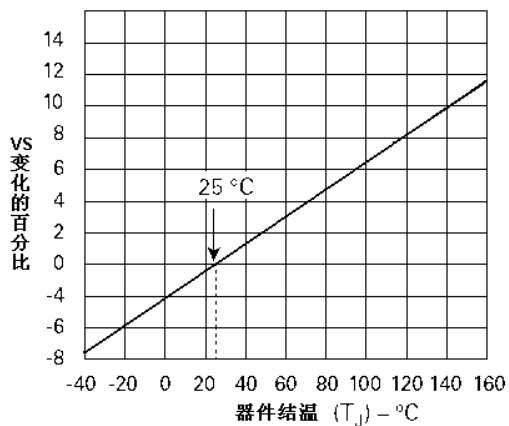

$C_o$  随偏置电压的变化率（相对于  $V_R=1V$ ）

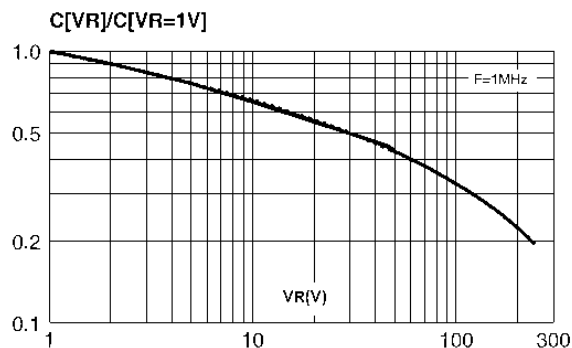

封装尺寸

SMB  
(DO-214AA)

Ref.	Dimensions			
	Millimeters		Inches	
	Min.	Max.	Min.	Max.
A1	1.90	2.45	0.075	0.096
A2	0.05	0.20	0.002	0.008
b	1.95	2.20	0.077	0.087
c	0.15	0.40	0.006	0.016
E	5.10	5.60	0.201	0.220
E1	4.05	4.60	0.159	0.181
D	3.30	3.95	0.130	0.156
L	0.75	1.50	0.030	0.059



### DO-15

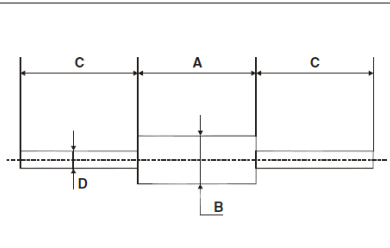

Ref.	Dimensions			
	Millimeters		Inches	
	Min.	Max.	Min.	Max.
A	6.05	6.75	0.238	0.266
B	2.95	3.53	0.116	0.139
C	26	31	1.024	1.220
D	0.71	0.88	0.028	0.035

### SMA (DO-214AC)

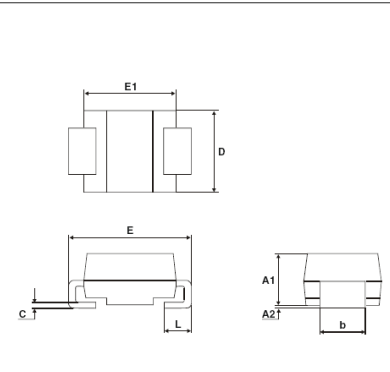

Ref.	Dimensions			
	Millimeters		Inches	
	Min.	Max.	Min.	Max.
A1	1.90	2.45	0.075	0.094
A2	0.05	0.20	0.002	0.008
b	1.25	1.65	0.049	0.065
c	0.15	0.40	0.006	0.016
D	2.25	2.90	0.089	0.114
E	4.80	5.35	0.189	0.211
E1	3.95	4.60	0.156	0.181
L	0.75	1.50	0.030	0.059

### 命名规则

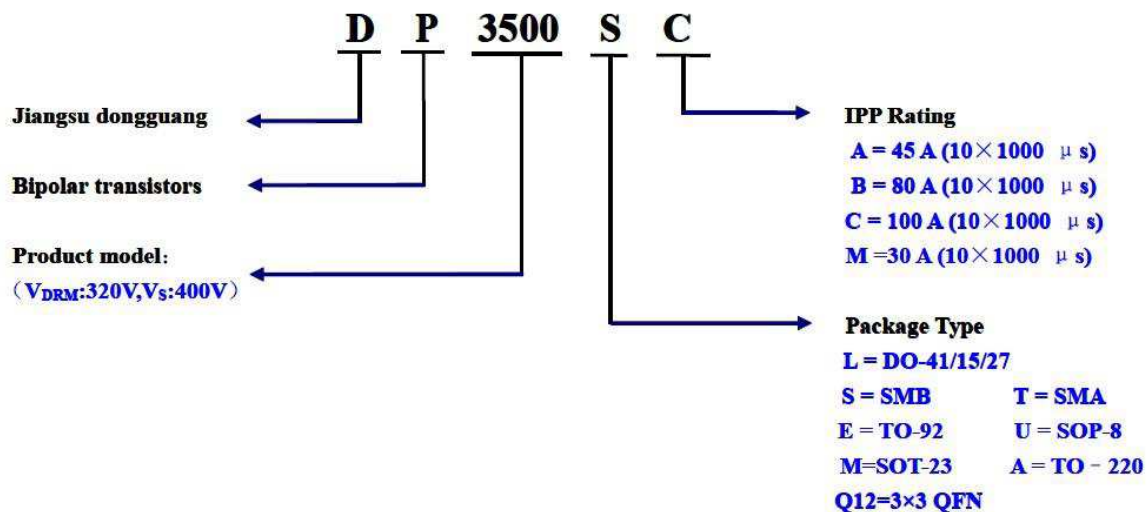



## DP2100LA&amp;DP2100SA&amp;DP2100TA



半导体放电管

版本号  
201603-A

## Description

The SDT is a kind of overvoltage protection device. It is designed at the PNP structure. High pulse current can cross SDT.

## Features and Benefits

- Low voltage and overshoot
- Low on-state voltage
- Does not degrade with use
- Fails short circuit when surged in excess of ratings
- Low capacitance

## Characteristic parameters

## 应用领域

symbol	Rated value	unit
$V_{DRM}$	180	V
$V_S$	240	V
$I_H$	150	mA

DP2100 are designed to protect communication equipment, appliances and Industrial And Control Instrumentation Equipment from damaging overvoltage transients.

Package : SMB (DO-214AA), DO-15, SMA (DO-214AC)

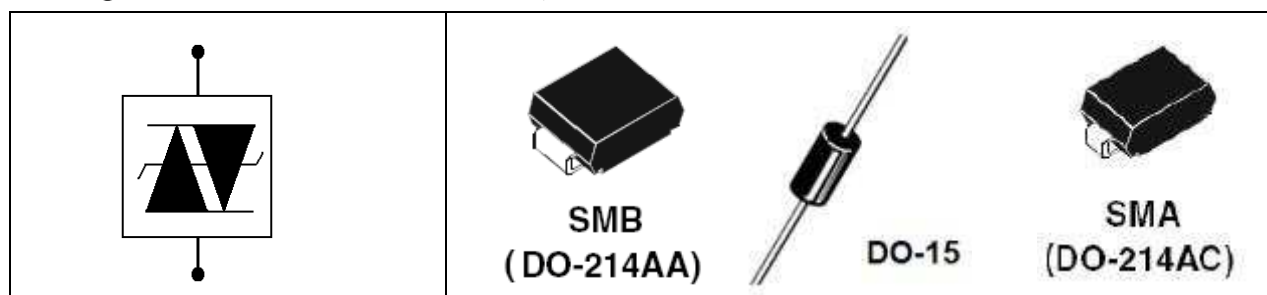

## Electrical Parameters

Parameter	symbol	Test conditions	Value			unit
			Min.	Typ.	Max.	
Leakage Voltage	$V_{DRM}$	$I=5\mu A$	180			V
Leakage Current	$I_{DRM}$	$V=V_{DRM}$			5	$\mu A$
Switching Voltage	$V_S$	100KV/s			240	V
Switching Current	$I_S$	100KV/s			800	mA
Holding Current	$I_H$	10A, 10/1000 $\mu s$	150			mA
On-state Voltage	$V_T$	$I_T=2.2A$			4	V
On-state Current	$I_T$	Rating value		2.2		A
Off-state Capacitance	$C_o$	1MHz, 2V offset			35	pF
Peak Pulse Current	$I_{PP}$	10/1000 $\mu s$			50	A

■ 热特性

Symbol	Parameter	Value	Unit
$T_J$	Operating Junction Temperature	-40~+150	°C
$T_S$	Storage Temperature Range	-65~+150	°C

■ Typical characteristic curve

Tr x Td Pulse waveform

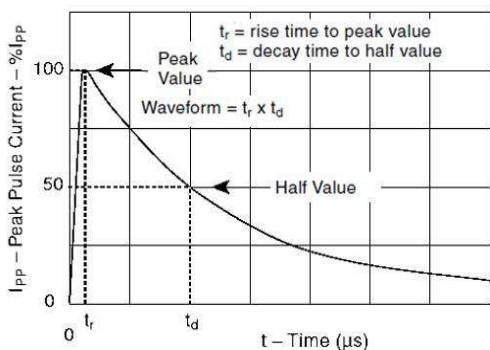

Normalized DC holding current vs. case temperature

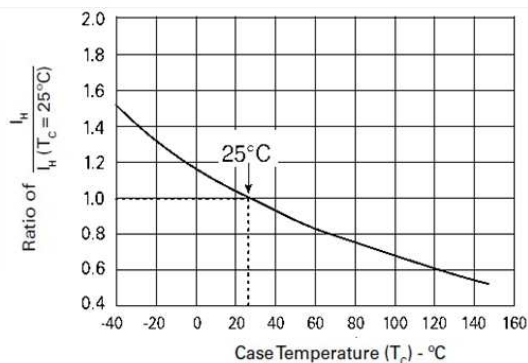

Vs change vs. junction temperature

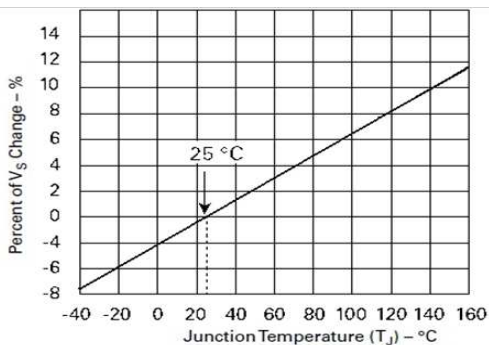

Co change vs. bias voltage (VR=1V)

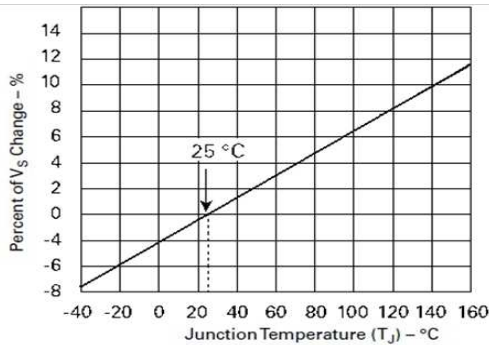

Package size

**SMB**  
**(DO-214AA)**

Ref.	Dimensions			
	Millimeters		Inches	
	Min.	Max.	Min.	Max.
A1	1.90	2.45	0.075	0.096
A2	0.05	0.20	0.002	0.008
b	1.95	2.20	0.077	0.087
c	0.15	0.40	0.006	0.016
E	5.10	5.60	0.201	0.220
E1	4.05	4.60	0.159	0.181
D	3.30	3.95	0.130	0.156
L	0.75	1.50	0.030	0.059



DO-15

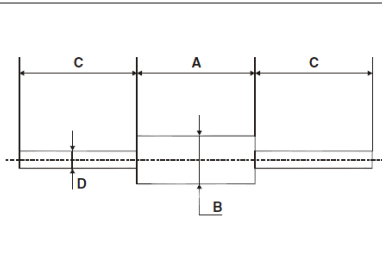

Ref.	Dimensions			
	Millimeters		Inches	
	Min.	Max.	Min.	Max.
A	6.05	6.75	0.238	0.266
B	2.95	3.53	0.116	0.139
C	26	31	1.024	1.220
D	0.71	0.88	0.028	0.035

SMA  
(DO-214AC)

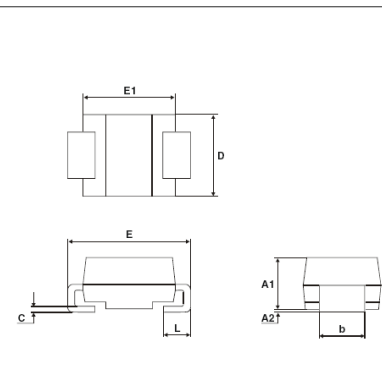

Ref.	Dimensions			
	Millimeters		Inches	
	Min.	Max.	Min.	Max.
A1	1.90	2.45	0.075	0.094
A2	0.05	0.20	0.002	0.008
b	1.25	1.65	0.049	0.065
c	0.15	0.40	0.006	0.016
D	2.25	2.90	0.089	0.114
E	4.80	5.35	0.189	0.211
E1	3.95	4.60	0.156	0.181
L	0.75	1.50	0.030	0.059

Naming Rule

