

	DG1N60S	版本号：V1.0
	N 沟道增强型场效应晶体管 N-CHANNEL ENHANCEMENT MODE MOSFET	

产品概述 General Description

DG1N60S是N沟道增强型场效应晶体管，应用了东光微电的相关专利技术，采用自对准平面工艺及先进的终端耐压技术，降低了导通损耗，提高了开关特性，增强了雪崩耐量。该产品能应用于多种功率开关电路，使得电源能效更高，系统更加小型化。

DG1N60S is an N-channel enhancement mode MOSFET, which is produced using Dongguang Micro-electronics's proprietary. The self-aligned planar process and improved terminal technology reduce the conduction loss, improve switching performance and enhance the avalanche energy. The transistor can be used in various power switching circuit for higher efficiency and system miniaturization.

主要参数 MAIN CHARACTERISTICS

V_{DSS}	600	V
I_D	0.5	A
$R_{DS(ON)}$	12	Ω
Crss	3.6	pF

产品特性

- 低Crss
- 低栅极电荷
- 开关速度快
- 高抗ESD能力
- 高抗dv/dt能力
- 100%雪崩测试

FETURES

- Low Crss
- Low gate charge
- Fast switching
- Improved ESD capability
- Improved dv/dt capability
- 100% avalanche energy test

应用领域

- 高频开关电源
- 电子镇流器
- UPS电源

APPLICATIONS

- High efficiency switch mode power supplies
- Electronic lamp ballasts
- UPS

符号 Symbol

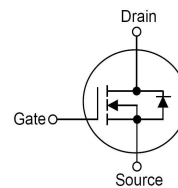

封装 Package

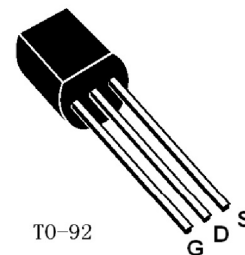

绝对最大额定值 ABSOLUTE MAXIMUM RATINGS (Tc=25°C)

参数名称 Parameter	符号 Symbol	数值 Value	单位 Unit
漏极-源极直流电压 Drain-Source Voltage	V_{DSS}	600	V
连续漏极电流 Continues Drain Current	I_D	Tc=25°C	0.5*
		Tc=100°C	0.3*
最大脉冲漏极电流 (注 1) Plused Drain Current (note 1)	I_{DM}	2	A
最高栅源电压 Gate-to-Source Voltage	V_{GS}	±30	V
单脉冲雪崩能量 (注 2) Single Pulsed Avalanche Energy (note 2)	E_{AS}	12.3	mJ
雪崩电流 (注 1) Avalanche Current (note 1)	I_{AR}	0.5	A
重复雪崩能量 (注 1) Repetitive Avalanche Energy (note 1)	E_{AR}	0.5	mJ
二极管反向恢复最大电压变化速率 (注 3) Peak Diode Recovery (note 3)	dv/dt	4.5	V/ns
耗散功率 Power Dissipation	P_D Tc=25°C	1.5	W
耗散功率减额因子 Power Dissipation Derating Factor	$P_{D(DF)}$ Above 25°C	0.012	W/°C
最高结温及存储温度 Operating and Storage Temperature Range	T_J, T_{STG}	150, -55~+150	°C
引线最高焊接温度 Maximum Temperature for Soldering	T_L	300	°C

热特性 THERMAL CHARACTERIATIC

参数名称 Parameter	符号 Symbol	最大 Max	单位 Unit
结到管壳的热阻 Thermal Resistance, Junction to Case	Rth(j-c)	83	W
结到环境的热阻 Thermal Resistance, Junction to Ambient	Rth(j-A)	140	W/°C

* 漏极电流由最高结温限制

* Drain current limited by maximum junction temperature

电特性 ELECTRICAL CHARACTERISTICS

关断特性 Off-Characteristics						
参数名称 Parameter	符号 Symbol	测试条件 Tests Conditions	最小 Min	典型 Type	最大 Max	单位 Unit
漏极-源极击穿电压 Drain-Source Breakdown Voltage	BV_{DSS}	$I_D=250\mu A, V_{GS}=0V$	600	-	-	V
击穿电压温度特性 Breakdown Voltage Temperature Coefficient	$\frac{\Delta BV_{DSS}}{\Delta T_J}$	$I_D=250\mu A$, referenced to $25^\circ C$	-	0.7	-	V/ $^\circ C$
零栅压下漏极漏电流 Zero Gate Voltage Drain Current	I_{DSS}	$V_{DS}=600V, V_{GS}=0V, T_C=25^\circ C$	-	-	1	μA
		$V_{DS}=480V, T_C=125^\circ C$	-	-	10	
正向栅极体漏电流 Gate-body leakage current, forward	I_{GSSF}	$V_{DS}=0V, V_{GS}=30V$	-	-	100	nA
反向栅极体漏电流 Gate-body leakage current, reverse	I_{GSSR}	$V_{DS}=0V, V_{GS}=-30V$	-	-	-100	nA

通态特性 On-Characteristics						
参数名称 Parameter	符号 Symbol	测试条件 Tests Conditions	最小 Min	典型 Type	最大 Max	单位 Unit
阈值电压 Gate Threshold Voltage	$V_{GS(th)}$	$V_{DS}=V_{GS}, I_D=250\mu A$	2.0	-	4.0	V
静态导通电阻 Static Drain-Source On-Resistance	$R_{DS(on)}$	$V_{GS}=10V, I_D=0.25A$	-	9.5	12	Ω
正向跨导 Forward Transconductance	g_{fs}	$V_{DS}=40V, I_D=0.25A$ (note4)	-	0.5	-	S

动态特性 Dynamic Characteristics						
参数名称 Parameter	符号 Symbol	测试条件 Tests Conditions	最小 Min	典型 Type	最大 Max	单位 Unit
输入电容 Input capacitance	C_{iss}	$V_{DS}=25V, V_{GS}=0V, f=1.0MHz$	-	130	170	pF
输出电容 Output capacitance	C_{oss}		-	19	25	pF
反向传输电容 Reverse transfer capacitance	C_{rss}		-	3.5	6	pF

开关特性 Switching Characteristics

参数名称 Parameter	符号 Symbol	测试条件 Tests Conditions	最小 Min	典型 Type	最大 Max	单位 Unit
延迟时间Turn-On delay time	$t_d(\text{on})$	$V_{DD}=300V, I_D=0.5A, R_G=25\Omega$ (note 4, 5)	-	7	24	ns
上升时间Turn-On rise time	t_r		-	21	52	ns
延迟时间Turn-Off delay time	$t_d(\text{off})$		-	13	36	ns
下降时间Turn-Off Fall time	t_f		-	27	64	ns
栅极电荷总量Total Gate Charge	Qg	$V_{DS}=480V, I_D=0.5A, V_{GS}=10V$ (note 4, 5)	-	4.8	6.2	nC
栅-源电荷Gate-Source charge	Qgs		-	0.7	-	nC
栅-漏电荷Gate-Drain charge	Qgd		-	2.7	-	nC

**漏-源二极管特性及最大额定值
Drain-Source Diode Characteristics and Maximum Ratings**

参数名称 Parameter	符号 Symbol	测试条件 Tests Conditions	最小 Min	典型 Type	最大 Max	单位 Unit
正向最大连续电流 Maximum Continuous Drain-Source Diode Forward Current		I_S	-	-	0.5	A
正向最大脉冲电流 Maximum Pulsed Drain-Source Diode Forward Current		I_{SM}	-	-	2.0	A
正向压降 Drain-Source Diode Forward Voltage	V_{SD}	$V_{GS}=0V, I_S=0.5A$	-	-	1.5	V
反向恢复时间 Reverse recovery time	t_r	$V_{GS}=0V, I_S=0.5A$ $di_F/dt=100A/\mu s$ (note 4)	-	190	-	ns
反向恢复电荷 Reverse recovery charge	Q_{rr}		-	0.9	-	μC

注释:

- 1: 脉冲宽度由最高结温限制
- 2: $L=90mH, I_{AS}=0.5A, V_{DD}=50V, R_G=25\Omega$, 起始结温 $T_J=25^\circ C$
- 3: $I_{SD} \leq 0.5A, di/dt \leq 300A/\mu s, V_{DD} \leq BV_{DSS}$, 起始结温 $T_J=25^\circ C$
- 4: 脉冲测试: 脉冲宽度 $\leq 300\mu s$, 占空比 $\leq 2\%$
- 5: 基本与工作温度无关

Notes:

- 1: Pulse width limited by maximum junction temperature
- 2: $L=90mH, I_{AS}=0.5A, V_{DD}=50V, R_G=25\Omega$, Starting $T_J=25^\circ C$
- 3: $I_{SD} \leq 0.5A, di/dt \leq 300A/\mu s, V_{DD} \leq BV_{DSS}$, Starting $T_J=25^\circ C$
- 4: Pulse Test: Pulse Width $\leq 300\mu s$, Duty Cycle $\leq 2\%$
- 5: Essentially independent of operating temperature

特征曲线 ELECTRICAL CHARACTERISTICS (curves)



图1. 输出特性曲线
Fig. 1 On-State Characteristics



图2. 传输特性曲线
Fig. 2 Transfer Characteristics

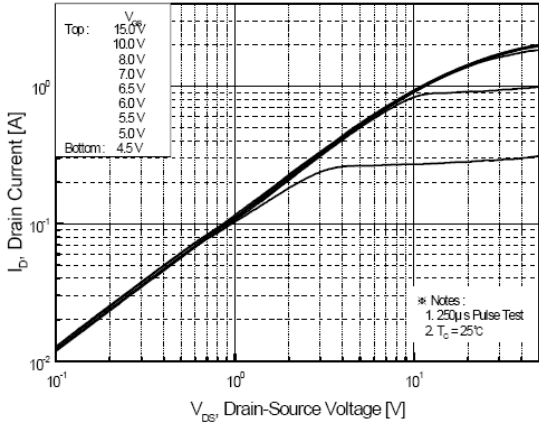

图3. 击穿电压随温度变化曲线
Fig. 3 Breakdown Voltage Variation vs Temperature

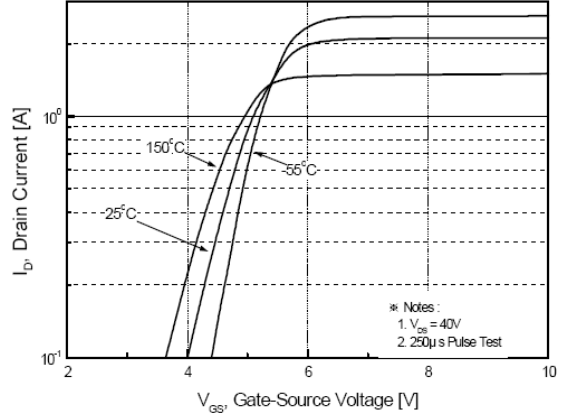

图4. 导通电阻随温度变化曲线
Fig. 4 On-Resistance Variation vs Temperature

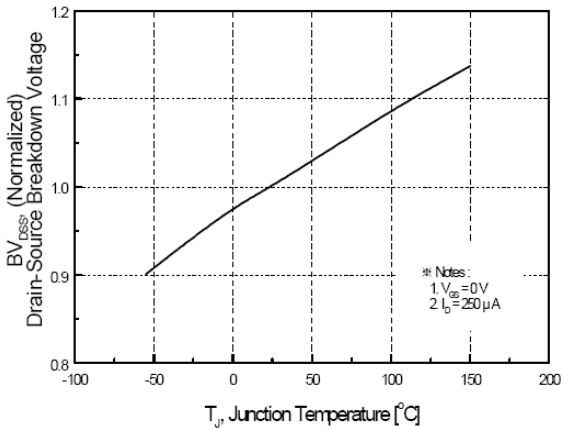

图5. 电容特性曲线
Fig. 5 Capacitance Characteristics

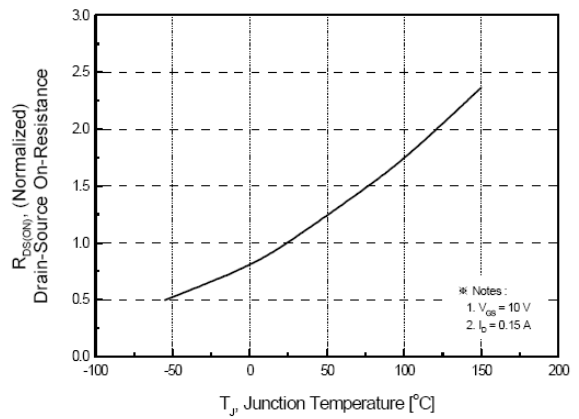

图6. 栅电荷特性曲线
Fig. 6 Gate Charge Characteristics

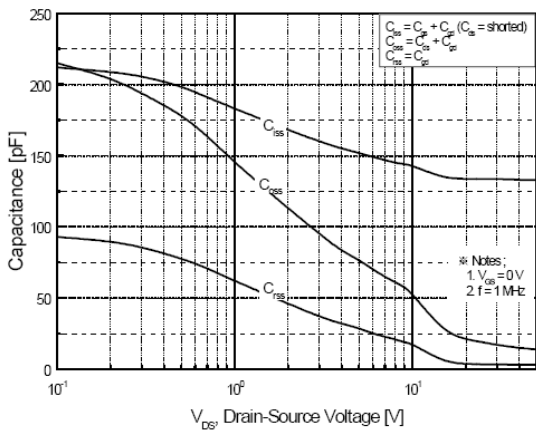

图7. 最大安全工作区
Fig. 7 Maximum Safe Operating Area

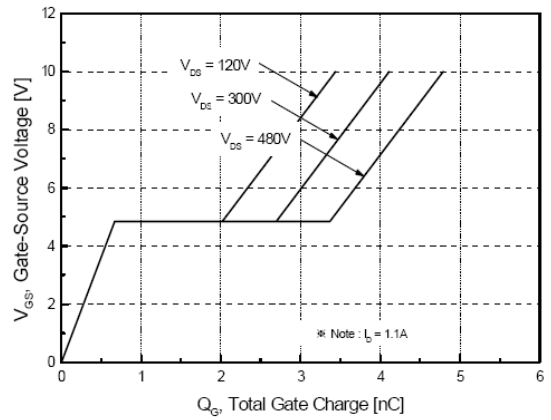

图8. 最大漏极电流随温度变化曲线
Fig. 8 Maximum Drain Current vs Case Temperature

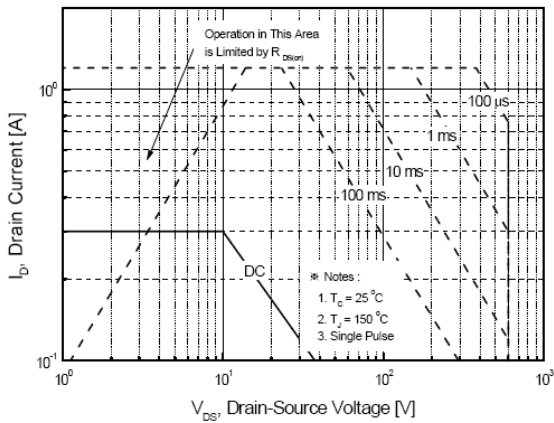

图9. 瞬态热响应曲线(TO-92)
Fig. 9 Transient Thermal Response Curve (TO-92)

测试电路及波形 TEST CIRCUITS AND WAVEFORMS

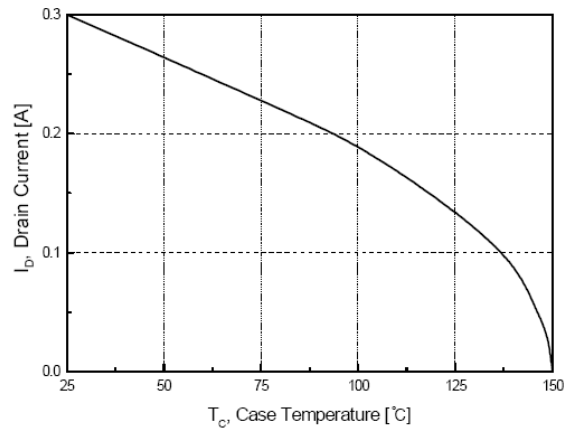

图10. 开关特性测试

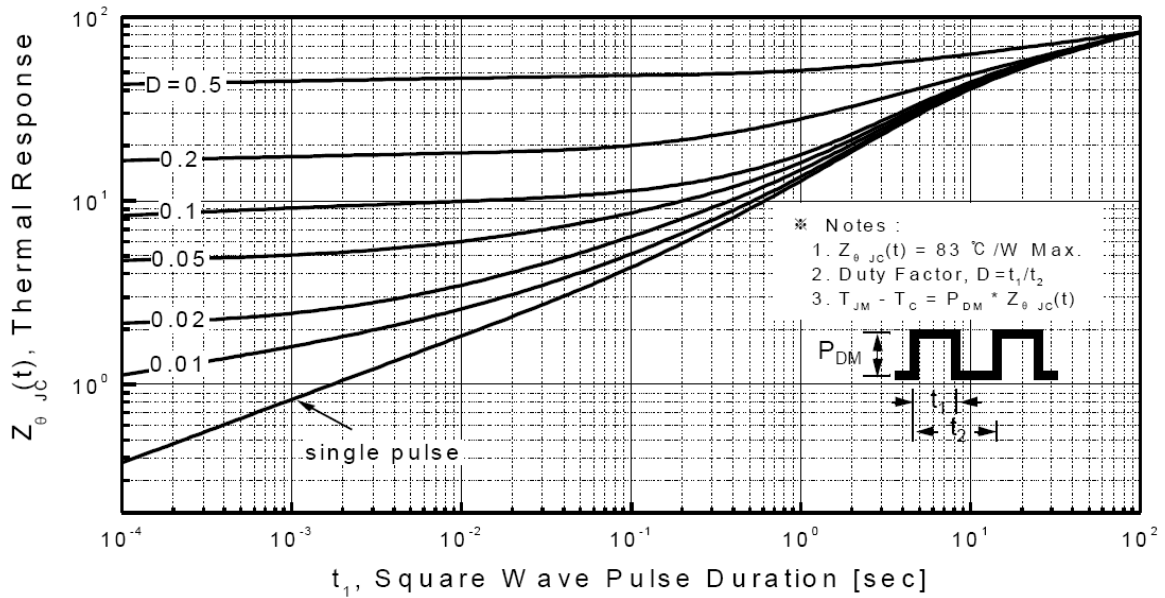
Fig.10 Resistive Switching Test Circuit & Waveforms

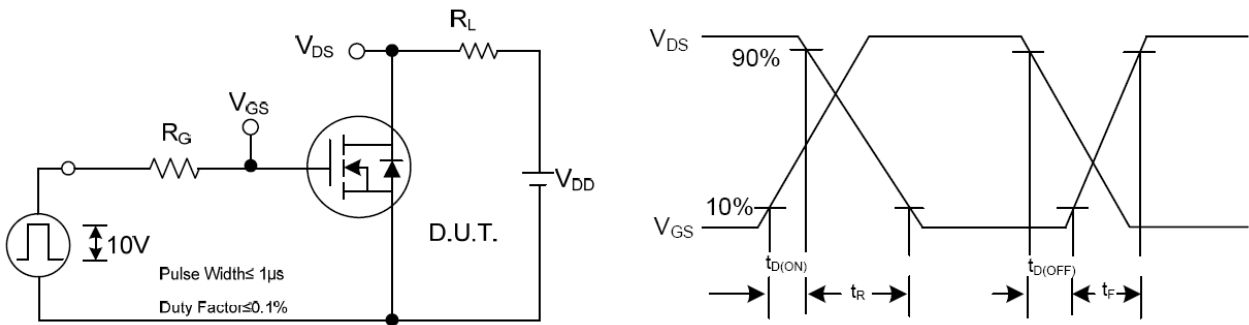

图11. 栅电荷测试

Fig.11 Gate Charge Test Circuit & Waveform

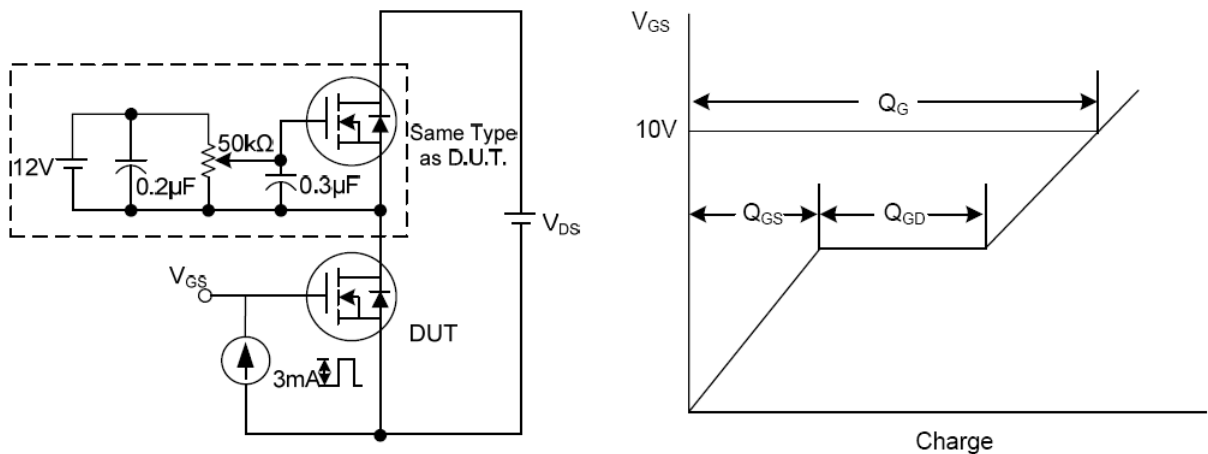

图12. 雪崩能量测试

Fig.12 Unclamped Inductive Switching Test Circuit & Waveforms

封装尺寸 TPACKAGE MECHANICAL DATA

TO-92

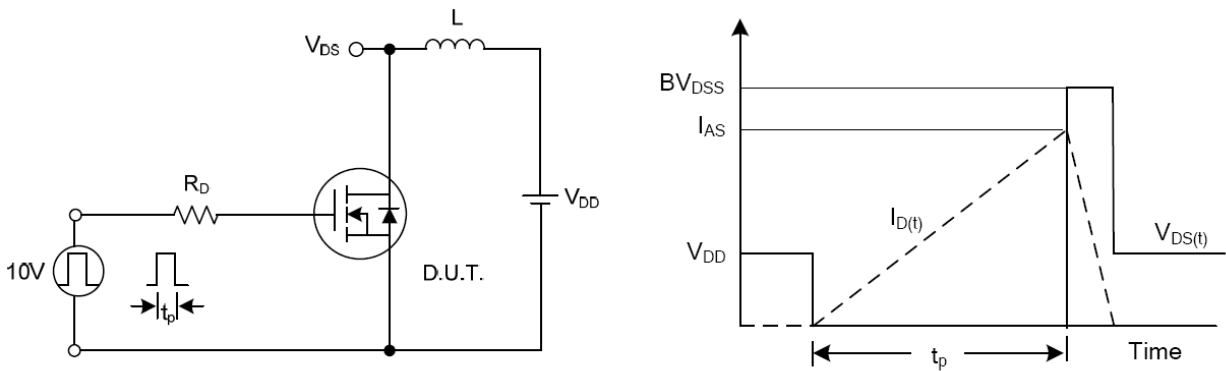