

 <b>D. G. M. E.</b>	BTA/BTB20CW/BW	版本号: V1.0
	双向可控硅(三项限) Triacs (3quadrants)	

## 产品概述      General Description

BTA/BTB20双向可控硅采用穿通隔离台面结构, 复合玻璃钝化PN结表面保护工艺技术, 三象限触发, 抗干扰能力强, 可靠性高。

**BTA/BTB20** Triacs is fabricated using separation diffusion processes ,the junction termination areas are passivated with glass. Thanks to highly dv/dt and reliability,the Triacs series is suitable for domestic lighting ,heating and motor speed controllers.

## 产品特点      MAIN FEATURES

- |   |   |
|---|---|
| <ul style="list-style-type: none"> <li>● 表面玻璃钝化, 可靠性高</li> <li>● dv/dt高</li> <li>● 通态压降低</li> <li>● Rohs环保产品</li> </ul> | <ul style="list-style-type: none"> <li>● Glass-Passivated Surface For Reliability</li> <li>● highly dv/dt</li> <li>● Low on-state voltage</li> <li>● Rohs Products</li> </ul> |
|---|---|

## 应用领域      Applications

主要应用于调温控制, 调光控制, 调速控制...等。  
domestic lighting ,heating and motor speed controllers.

## 主要参数 MAIN CHARACTERISTICS

参数 Parameter	数值 Value	单位 Unit
$I_T (RMS)$	20	A
$V_{DRM}/V_{RRM}$	600	V
$I_{GT}$	50	mA

### 封装Package: T0-220

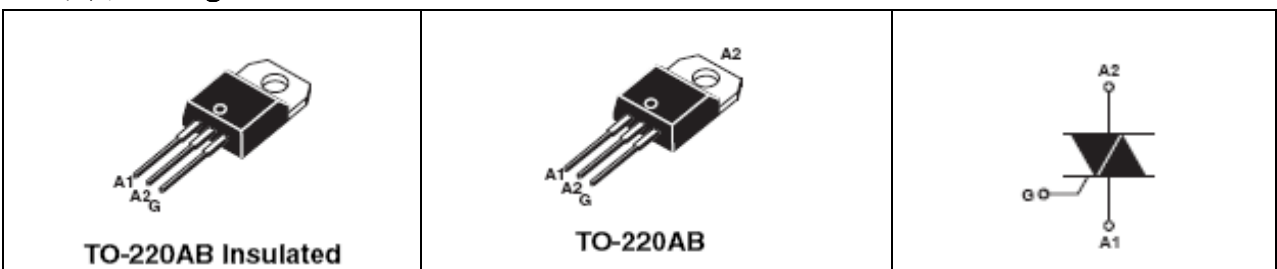

## 极限值 (除非另有规定, $T_a=25^\circ\text{C}$ ) ABSOLUTE RATINGS

( $T_j=25^\circ\text{C}$ , unless otherwise specified)

参数 Parameter	符号 symbol	数值 Value	单位 Unit
RMS 通态电流 on-state RMS current	TO-220ABIns. $T_C=85^\circ\text{C}$	20	A
	TO-220AB $T_C=100^\circ\text{C}$		
通态峰值浪涌电流 Non repetitive surge peak on-state current	$t=20\text{ms}$	210	A
$I^2t$ 耗散值 $I^2t$ for fusing	$T_p=10\text{ms}$	200	$\text{A}^2\text{s}$
电流上升率 Repetitive rate of rise of on-state current after triggering	$F=120\text{Hz}, T_j=125^\circ\text{C}$	50	$\text{A}/\mu\text{s}$
门极峰值电流 Peak gate current		4	A
平均门极耗散功率 Average gate power		1.0	W
贮存结温范围 Storage temperature		$-40\text{--}+150$	$^\circ\text{C}$
工作结温范围 Operation junction temperature		$-40\text{--}+125$	$^\circ\text{C}$

## 电参数 (除非另有规定, $T_a=25^\circ\text{C}$ ) ABSOLUTE RATINGS

( $T_j=25^\circ\text{C}$ , unless otherwise specified)

参数名称 Parameter	符号 Symbol	测试条件 Test Conditions		规范值 Value		单位 Unit	
				CW	BW		
触发电流 Gate trigger current	$I_{GT}$	$V_D=12\text{V}, I_T=0.01\text{A}$	I - II - III	MAX	35	50	mA
触发电压 Gate trigger voltage	$V_{GT}$	$V_D=12\text{V}, I_T=0.01\text{A}$	I - II - III		1.5		V
维持电流 Holding current	$I_H$	$I_T=500\text{mA}$			40	50	mA
电压上升率 Rise of off- state voltage	$dv/dt$	$V_D=67\%V_{DRM}$		MIN	400	1000	$\text{V}/\mu\text{s}$
通态压降 Peak on-state voltage	$V_{TM}$	$I_T=28\text{A}$		MAX	1.55		V
断态漏电流 For Peak Repetitive ward Blocking Current	$I_{DRM}$	$V_D=V_{DRM}, T_j=125^\circ\text{C}$		MAX	1.0		mA

## 热特性 THERMAL RESISTANCES

参数 Parameter	符号 symbol	数值 Value		单位 Unit
Junction to case(AC)	$R_{th(j\text{-lead})}$	To-220ABIns.	1.1	$^\circ\text{C}/\text{W}$
		TO-220AB	2.0	
Junction to ambient	$R_{th(j\text{-a})}$	60		$^\circ\text{C}/\text{W}$

典型特性曲线ELECTRICAL CHARACTERISTICS(CURVES)

图1 最大耗散功率与RMS通态电流关系  
Fig.1.Maximum Power Dissipation Versus on-state current



图2 平均通态电流与Tc温度关系  
Fig.2. On-state Current Versus TL



图3 通态特性  
Fig.3.On-State Characteristics

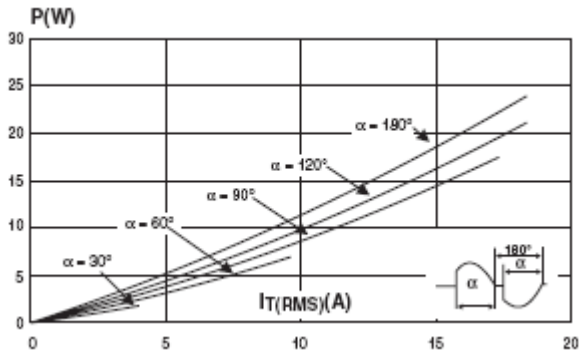

图4 通态浪涌峰值电流与周期数关系  
Fig.4.Surge Peak On-state Current Versus Number Cycles

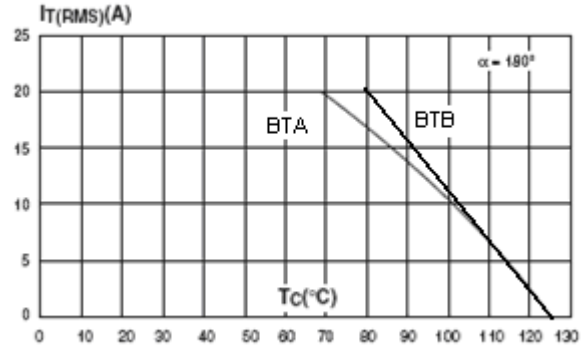

图5  $I_{GT}$ 、 $I_H$ 、 $I_L$ 相对值（相对于 $25^{\circ}C$ ）与结温关系  
Fig.5.Relative Variation Of Gate Trigger Current Holding Current And Latching Current Versus Junction Temperature (Typical Value)

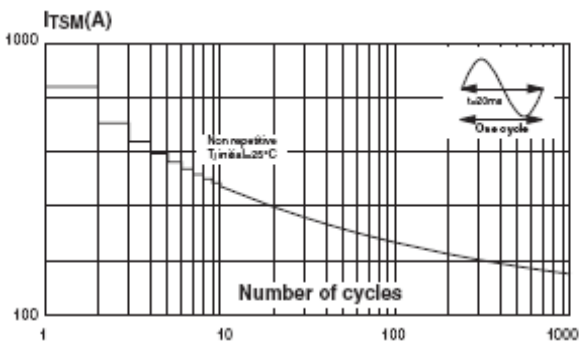

## TO-220AB外形图 Package Mechanical Data

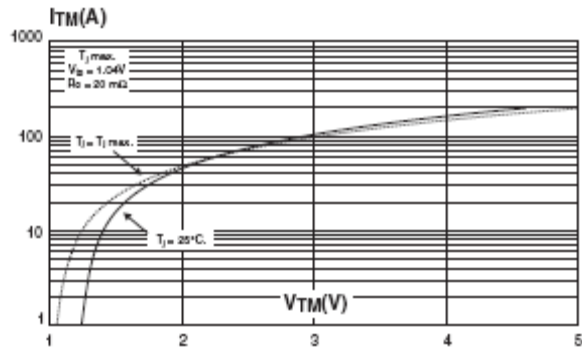
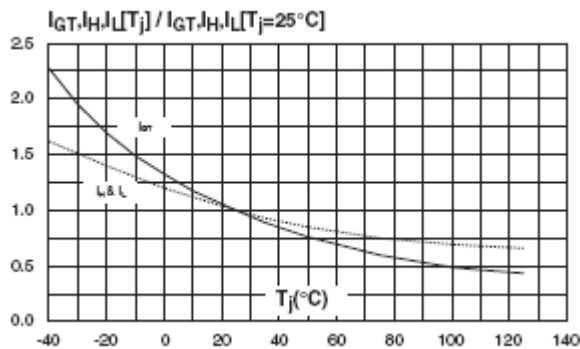
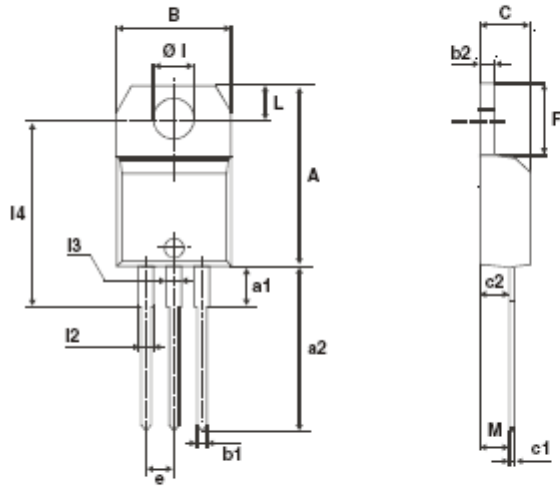

REF.	DIMENSIONS					
	Millimeters			Inches		
	Min.	Typ.	Max.	Min.	Typ.	Max.
A	15.20		15.90	0.598		0.625
a1		3.75			0.147	
a2	13.00		14.00	0.511		0.551
B	10.00		10.40	0.393		0.409
b1	0.61		0.88	0.024		0.034
b2	1.23		1.32	0.048		0.051
C	4.40		4.60	0.173		0.181
c1	0.40		0.70	0.019		0.027
c2	2.40		2.72	0.094		0.107
e	2.40		2.70	0.094		0.106
F	6.20		6.60	0.244		0.259
$\varnothing I$	3.75		3.85	0.147		0.151
I4	15.80	16.40	16.80	0.622	0.646	0.661
L	2.65		2.95	0.104		0.116
I2	1.14		1.70	0.044		0.066
I3	1.14		1.70	0.044		0.066
M		2.60			0.102	